

# **The introduction of Development for the Interoperability validation of smart grid user side equipment**

Electronic Testing Center, Taiwan

Hermes

[etc436@etc.org.tw](mailto:etc436@etc.org.tw)

# About ETC

- In 1983, the Ministry of Economic Affairs (MOEA) and Taiwan Electrical and Electronic Manufacturer's Association (TEEMA) collectively promoted the establishment of ETC.
- Based on the fundamental principle of serving customers and improving the quality of service, ETC provides various product testing and certification services with electric and electronic equipment and technology.

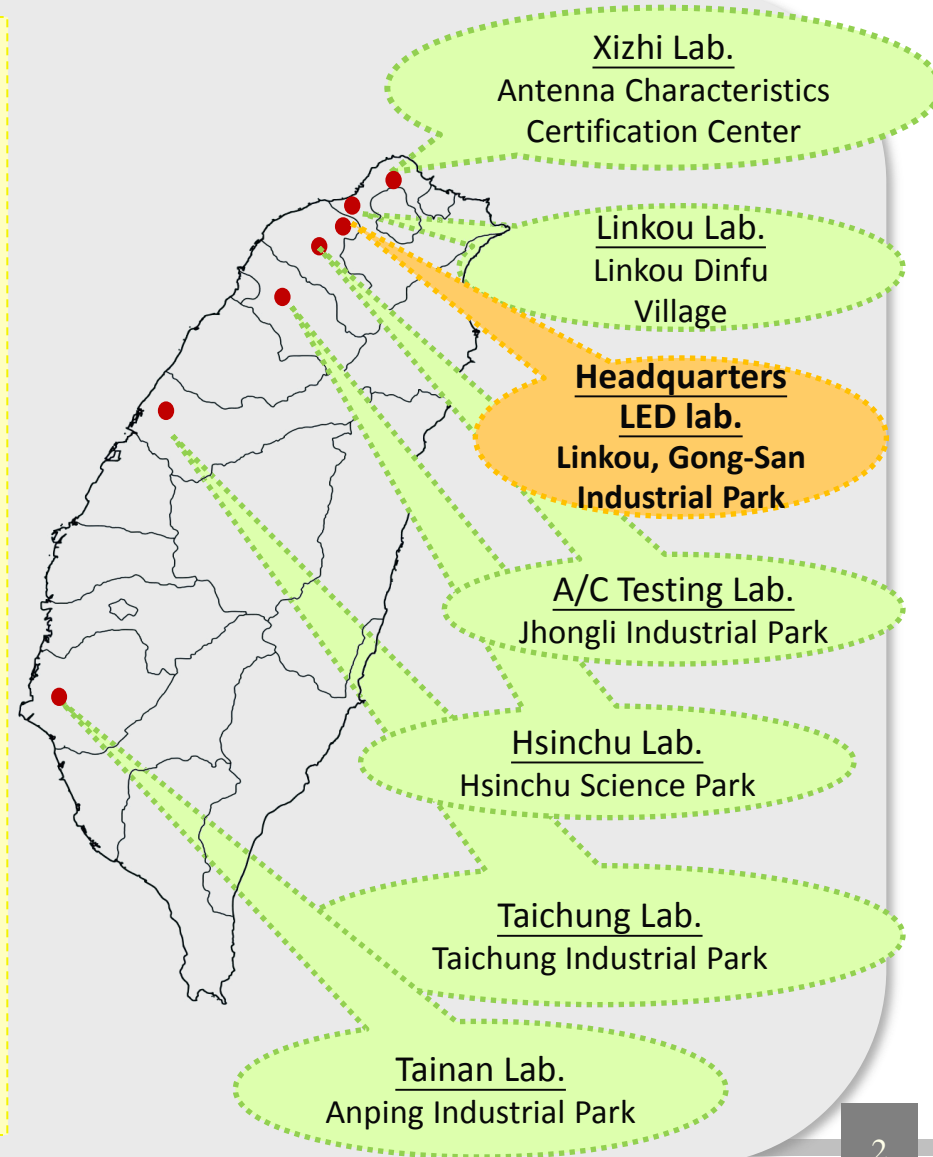

# Orientation

**A specialized institute which provide product testing and certification services by high technology**

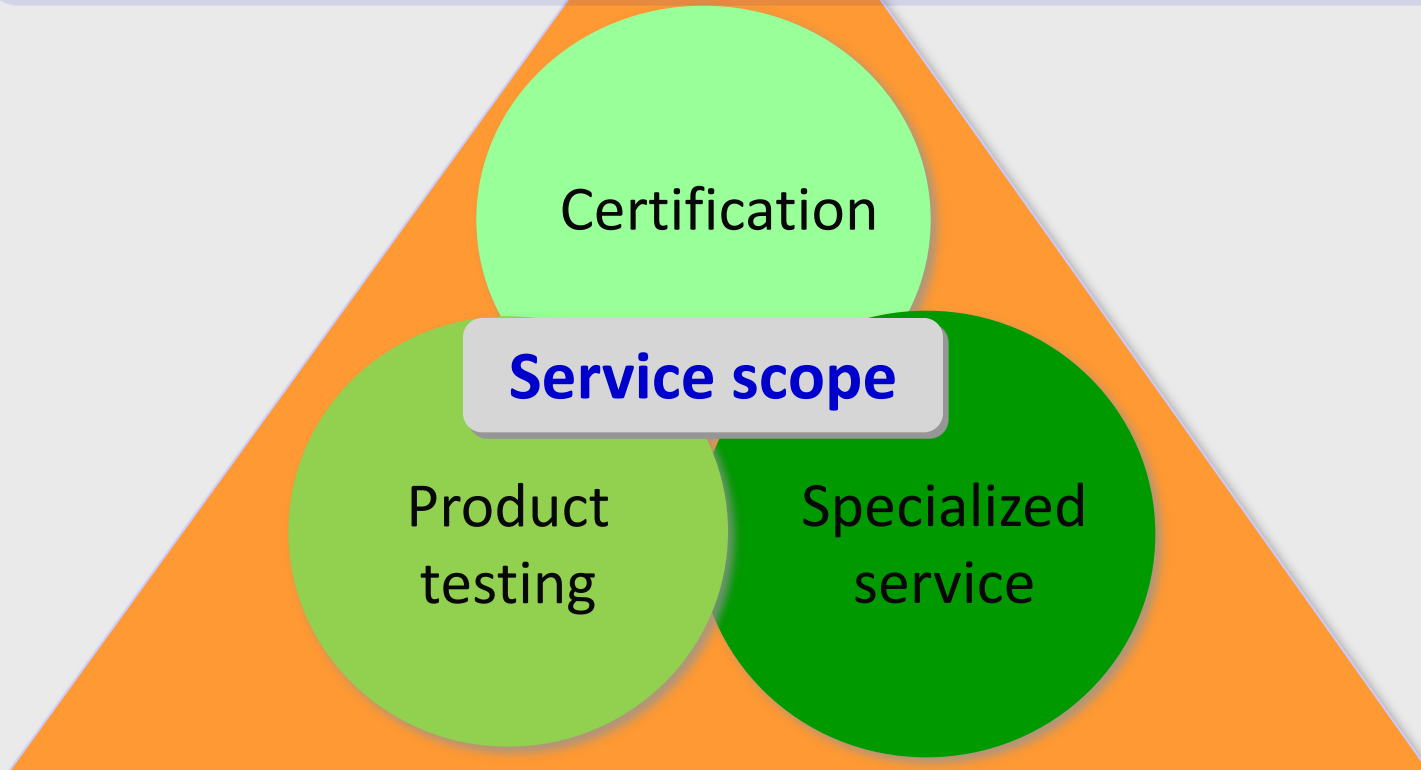

**Quality Policy** **To pursue excellence in service quality with a dedicated working attitude**

# Goal of Smart grid Project

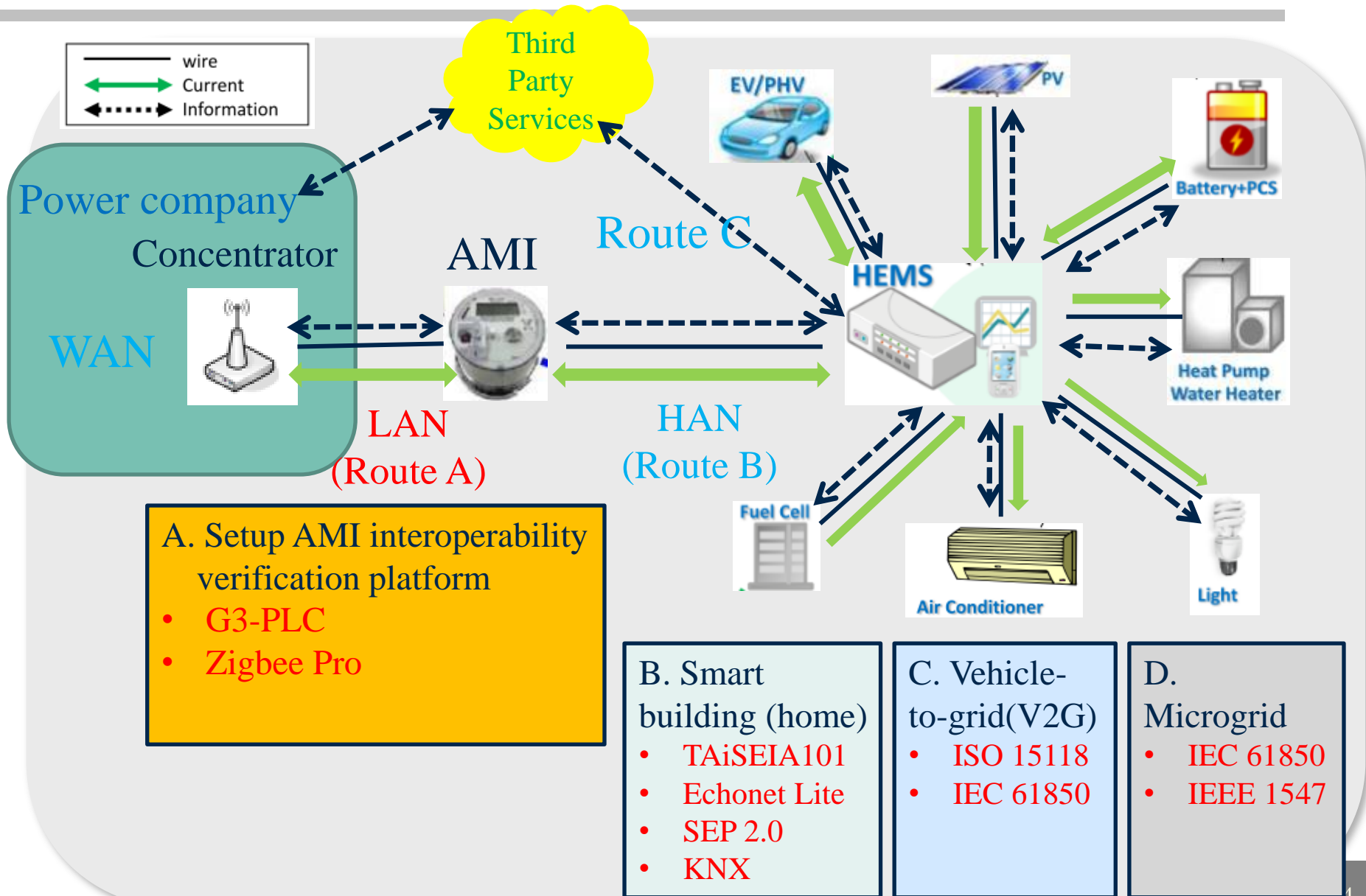

# Interoperability Research

## V2G interoperability verification platform research (IEC standards)

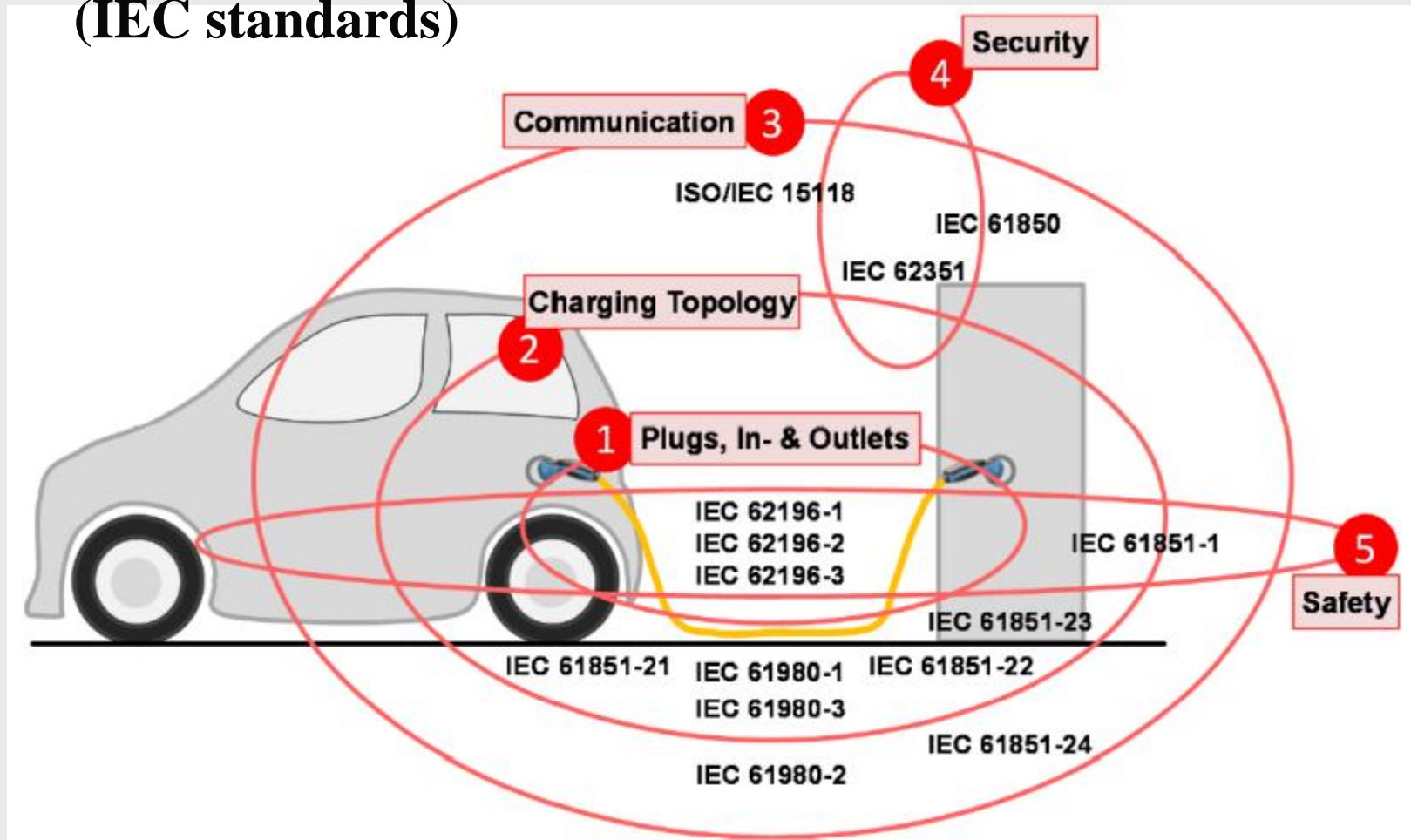

source : IEC 61850-90-8 draft

# Interoperability Research

(SAE standards)

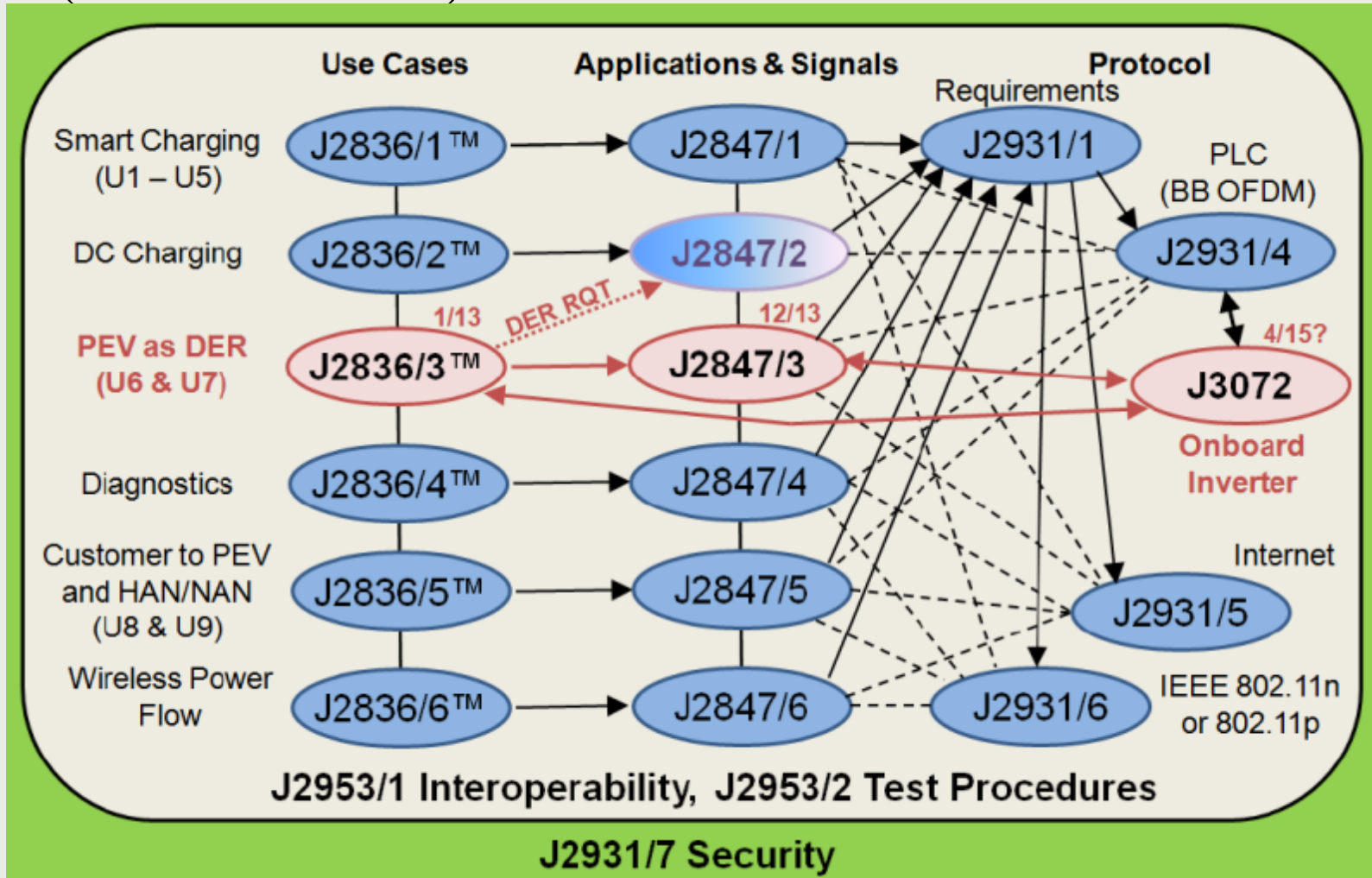

source : SAE Communication and Interoperability Task Force

# Goal of WT Project

Provide testing and certification for Taiwan future wind turbine industry development

- Communication for WT monitoring and control.



# Interoperability Research

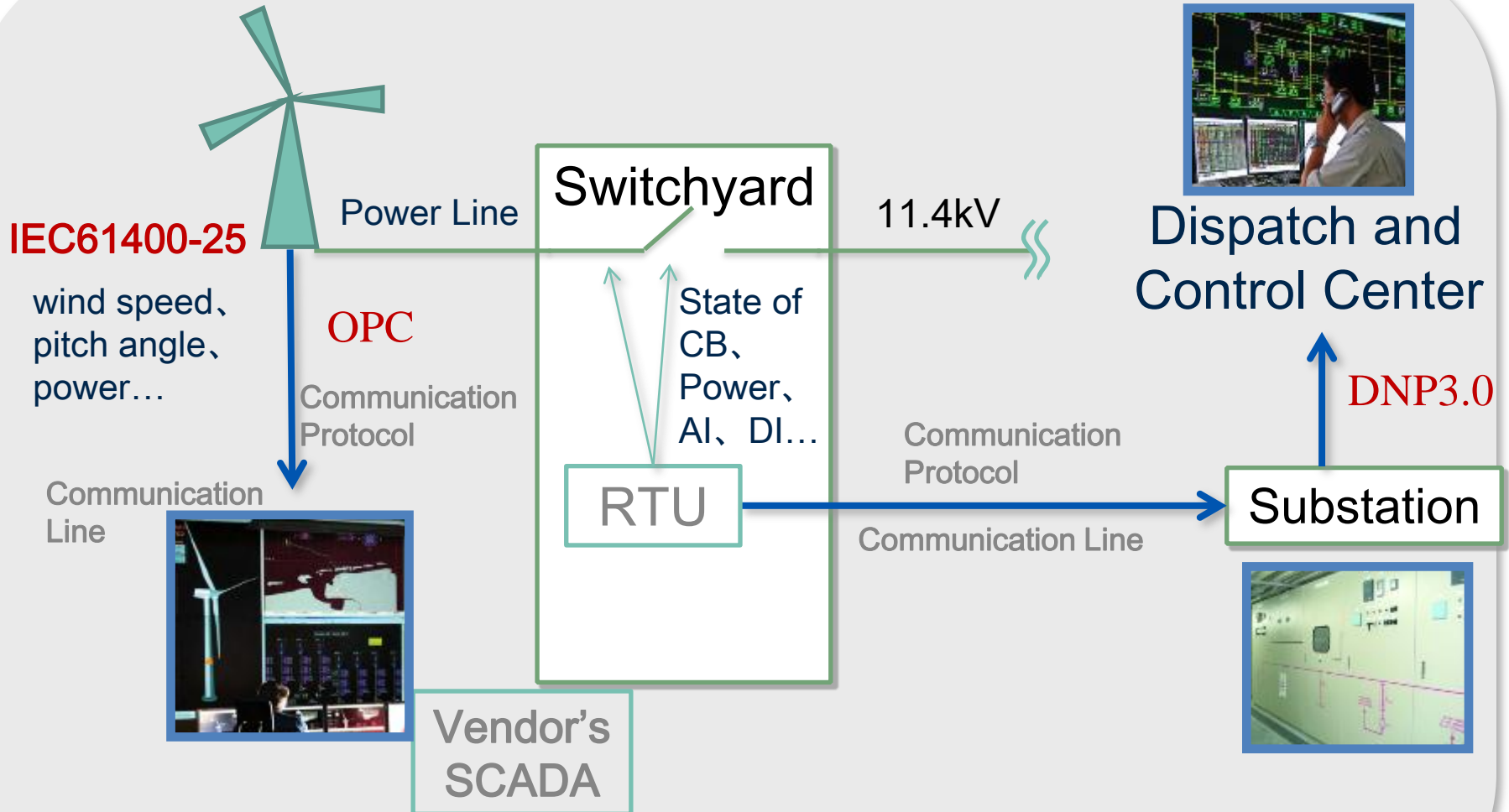

ETC is in charge of the communication of the Offshore Wind Turbine Test Field



# Interoperability Research

## Setup Offshore wind turbine test site communications simulation system

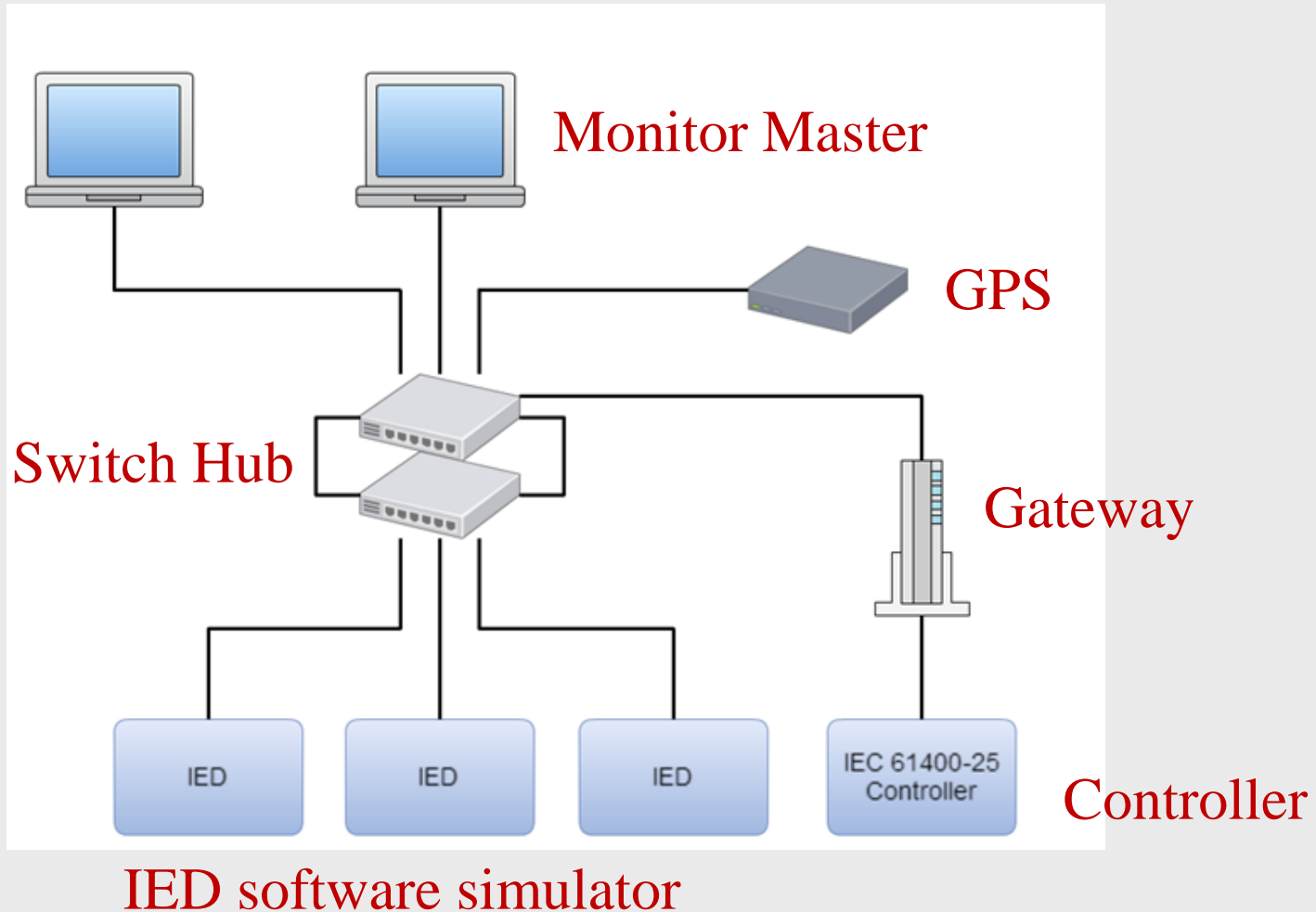

# Interoperability Research

Simulator and software  
(include DNP3.0 Modbus、DNP3.0 LAN)

The screenshot displays the ASE 2000 Communication Test Set software interface for DNP 3.0. The main window is titled "ASE 2000 Communication Test Set - dnp 3.0 MON <DNP 3.0>". It features a menu bar (File, Edit, View, Window, Properties, Events, Help) and a toolbar. The interface is divided into several panes:

- Point Values:** A table showing data points for RTU Harley.
 

RTU	Point	Name	Raw	Value	Limit
<b>RTU Harley</b>					
2	DI 0	BRKR X25	1	CLOSED	
2	DI 1	BRKR X27	1	CLOSED	
2	DI 2	BRKR X35	1	CLOSED	
2	DI 3	BRKR X37	1	CLOSED	
2	DI 4	CAP BNK 1	0	OUT	
2	DI 5	CAP BNK 2	0	OUT	
2	DI 6	SWH R24	1	CLOSED	
2	DI 7	SWH R40	1	OPEN	
2	AI 0	XFMR 123 MW	-847	169.40	(-175, 175)
2	AI 1	XFMR 456 MW	-842	168.40	(-175, 175)
2	AI 2	XFMR 123 MVAR	-839	100.68	
2	AI 3	XFMR 456 MVAR	-849	101.88	
2	AI 4	GEN 1 MW	-833	291.55	(0, 275)
- Exchange List:** A list of communication events with checkboxes for various actions like "Reset Link", "Reset User", "Test", "Link Status", "Binary Input", etc.
- Line Monitor:** A hex dump and ASCII view of the communication stream. It shows a "Class 1/2/3/0 Data request" and a "Class 1/2/3/0 Data response" with detailed headers and data fields.

At the bottom, there is a status bar showing "Ready" and statistics: "Total 1832 1828 OK 1832 1828 No Resp 0 Par 0 0 Sec 0 0".



**Thank you!**

**<http://www.etc.org.tw/>**